

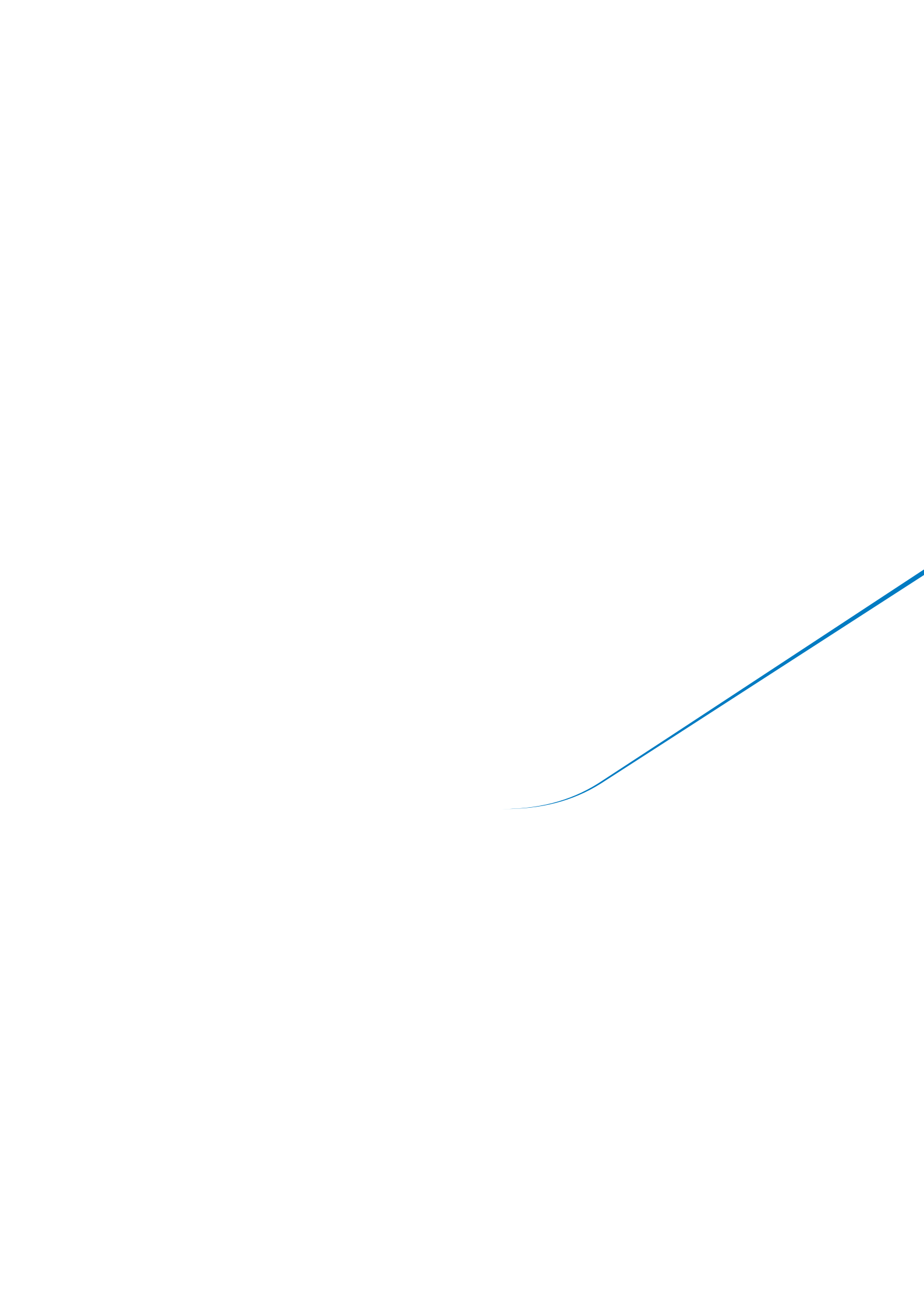

Expertise – Passion – Automation

**Your support on the road
to excellence**

SMC solutions for tyre industry



SMC and the Tyre Industry, a reliable rolling partnership

SMC, the world leader in pneumatic automation systems, has a long history of trusted partnerships with tyre producers and their machine builders.

“We all know that the tyre plays a crucial role in vehicle performance and safety and how, today, a tyre must be also fully integrated with the in-vehicle electronics systems.

We, at SMC, are fully aware of the demands of the “smart tyre” manufacturing process in terms of machinery complexity and new technologies.

That’s why you can always count on our dedicated team of tyre industry experts, capable of offering a wide portfolio of products and services, applicable to the areas of R&D/engineering, production, maintenance and logistics activities.

Whether it’s designing a new automatic pre-mixer dosing system for raw materials, implementing predictive maintenance in tyre building, increasing energy efficiency in curing or customising a green tyre handling system, SMC products, services and expertise can add tangible value to your project.

The tyre industry has always placed a high priority on innovation, competitiveness and sustainability: SMC is the partner you need to excel in these challenges.”

PAOLO GAMARINO

TYRE INDUSTRY MANAGER EUROPE





Your safety in our focus

Creating confidence with confidence. SMC is an innovative, reliable and strong partner for pneumatic and electrical automation technology. We accompany our customers throughout the entire life cycle of their plant and, for all relevant safety issues, we have competent and professional solutions at your disposal.



We understand your daily needs



Energise your efficiency

In our 24/7 economy and as governments, industries and consumers battle with in the quest for ever increasing supplies of energy, SMC has always been fully committed to assisting customers in reducing their bills and, of course, in making its modest contribution to global sustainability.

We want to share our 5 cornerstones of energy efficiency with you, so we can help you to embrace good energy policies for your business in a very intuitive and simple way:

- **Generate just what you need**
- **Recover what you generate**
- **Monitor your consumption**
- **Use only the essential**
- **Think efficient**





Smart Flexibility

This is the main concern of the Industry 4.0, Factory of the Future, Smart Factory or Digitalisation, you name it. It is no longer a question of mass production, but to do so in a personalised, cost-effective, fast and sustainable way.

This is what SMC's Smart Flexibility means to you:

- Flexibility in industrial networking
- Smart maintenance
- Flexibility in machine adjustments
- Smart energy efficiency



Sustainable management



We contribute to the sustainable growth and expansion of technological innovations through the manufacturing and sales of automatic control equipment.

That is why initiatives have been launched to achieve the SDGs (Sustainable Development Goals) adopted at the "United Nations Sustainable Development Summit":

- Sustainable measures to prevent climate change
- Healthy, safe and secure working environment
- Human resource development and diffusion of automatic control technology for the development base
- Social contribution activities

Size & weight optimisation



Nowadays space and weight are at a premium. SMC is on the way to downsizing your machine components, continually re-designing our products so you can achieve more efficient, compact and light machinery.

Take advantage of the benefits of size and weight optimisation:

- Save space and costs
- Increase productivity
- Reduce labour
- Improve reliability

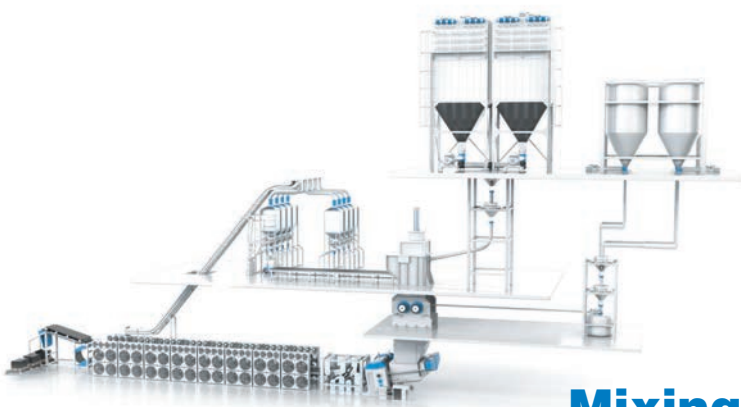

Mixing and compounding

p.8

And we understand your production process

Knowledge is power. By thoroughly understanding each stage of the tyre manufacturing process, from the initial material mixing to the final testing, we ensure that we find the best solution for any of your requirements.

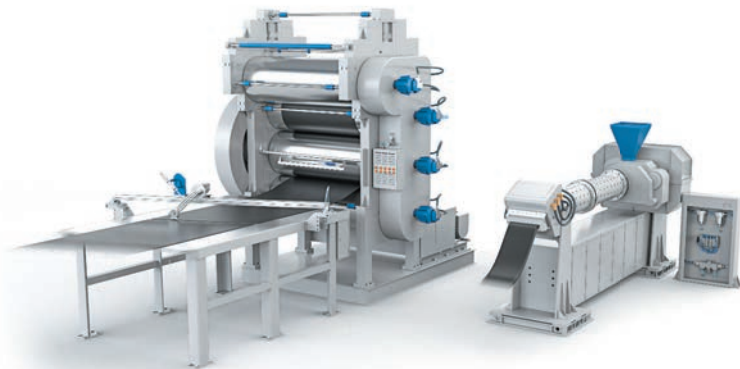

Extruding, calendaring and cutting

p.10

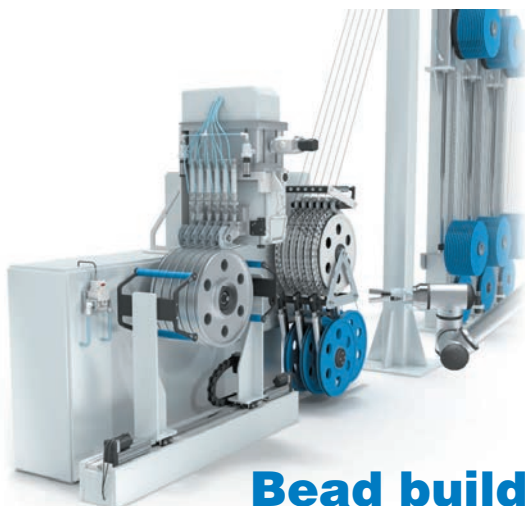

Bead building

p.12

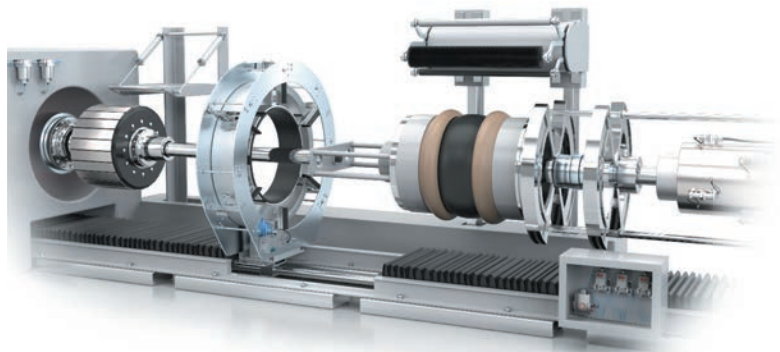

p.14

Tyre building



p.16

Curing

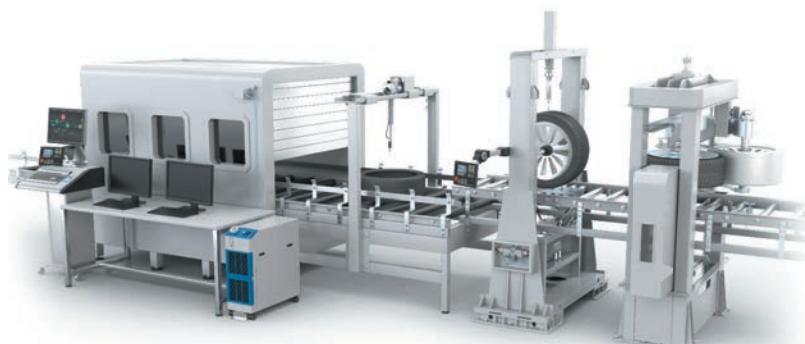

p.18

Inspection, handling and storage

Mixing and compounding

The initial stage of manufacturing a tyre can't be understood without talking about the harsh atmospheres and the demanding performance required by the transportation, dosing and weighting of the chemicals, and by the rubber compound mixing and cooling. For these systems, SMC offers a wide range of products specially designed to withstand aggressive environments and to assist in the full process automation.



**Large bore, tie rod cylinder
C95/CS2 Series**

Carry out high force operations with a robust but lightweight construction.



**Compact ATEX cylinder
55-CQ2 Series**

Perform minor manipulations safely in harsh environments with the ATEX compact cylinder 55-CQ2.

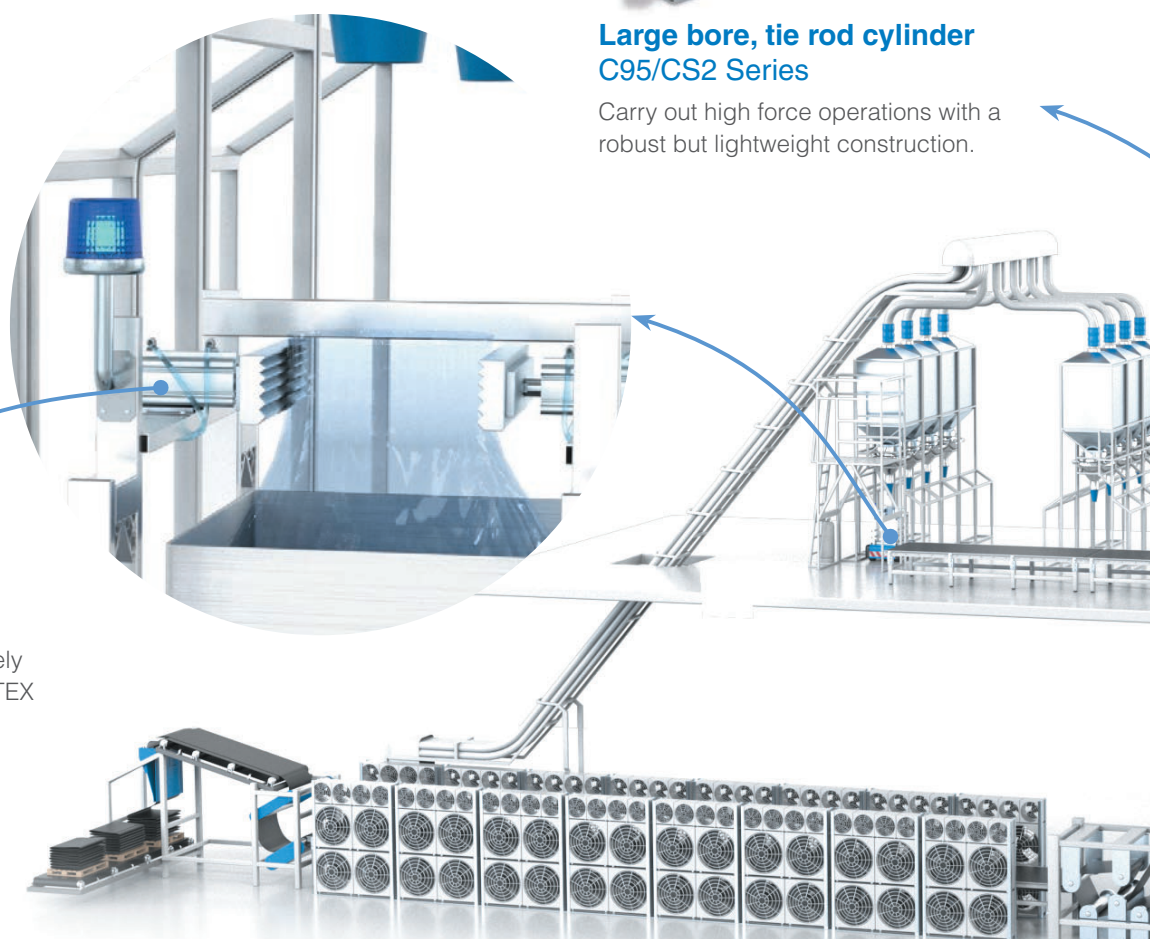

Facts over words

A cylinder that drove a pressure roll suffered many failures due to piston rod bending and rod end break. This issue caused frequent stoppages on the line and a reduction in productivity. The SMC team designed and manufactured a new rod end and fixing points, taking into account the actuator's working conditions. With this simple solution, unpredicted stoppages were eliminated, leading to significant time and cost savings.



Pulse valve, valve for dust collector
JSXFA Series

Guarantee an extremely long service life of the pulse valve for reverse-jet filter cleaning in carbon black transportation systems.

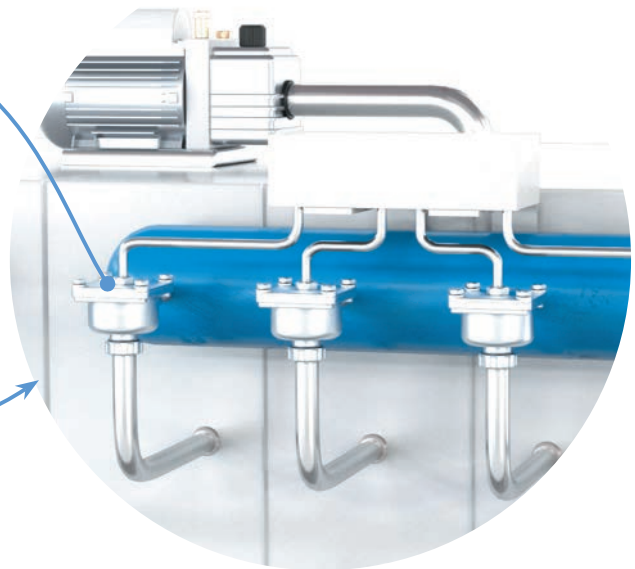

Refrigerated air dryer
IDFA Series

Avoid operational failure and pneumatic component degradation by removing moisture from the pneumatic system.



High precision digital pressure switch
ISE20/ZSE20 Series  **IO-Link**

Monitor the pressure and ensure the correct operation of the mixer and optimum process control.

Extruding, calendering and cutting

Components preparation is a continuous process requiring constant material feeding and long lines. It is of paramount importance that the machines work reliably, experiencing as few steps as possible and guaranteeing constant quality over time. In SMC you have the ideal partner for reliable solutions that adapt specifically to each process.



Ionizer IZT40/41/42/43 Series

Remove the static electricity generated by winding operations, preventing discharges to workers and other issues affecting the material rolls.

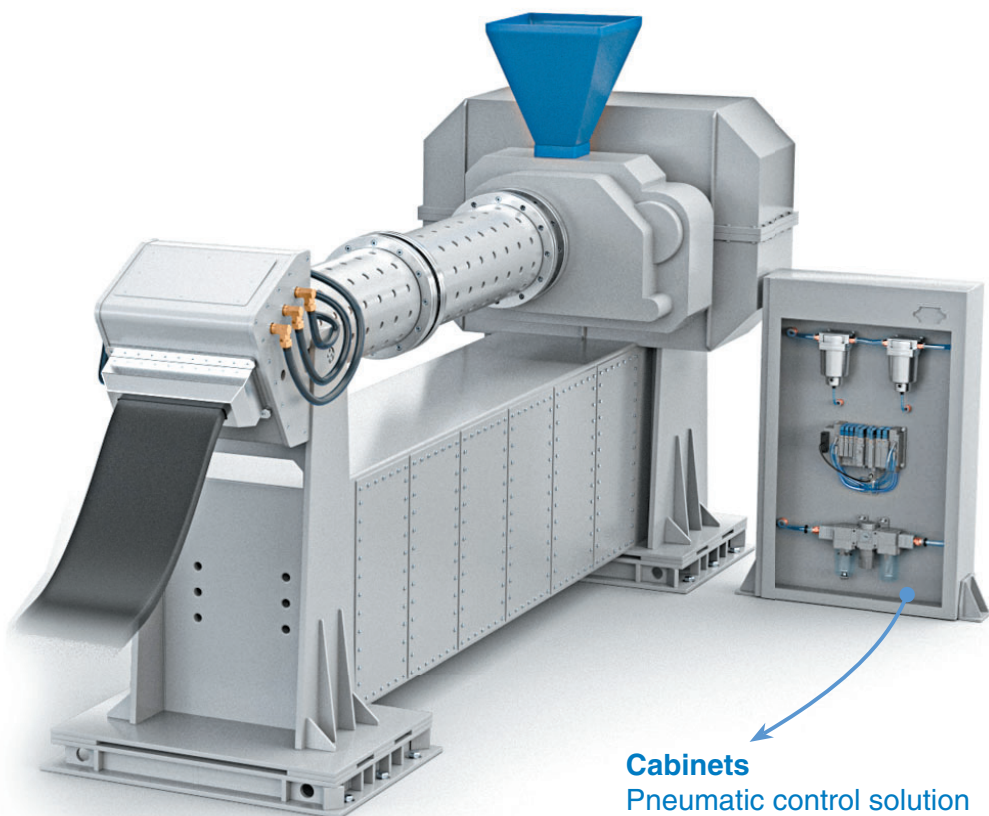

Cabinets Pneumatic control solution

Get fully customised cabinets specially designed to fulfill your machine automation needs.

Facts over words

When unrolling the nylon fabric cord used for calendering, the material was electrically charged due to the friction. This led to shocks for the personnel, wrinkling, and material imperfections in the manufacturing of the rubber compound. By means of our bar Ionizer **IZT40/41/42/43**, this problem was easily solved by simply placing it next to the material rolls.



**Precision regulator
IR Series**

Set the exact pressure for the cylinder operations.

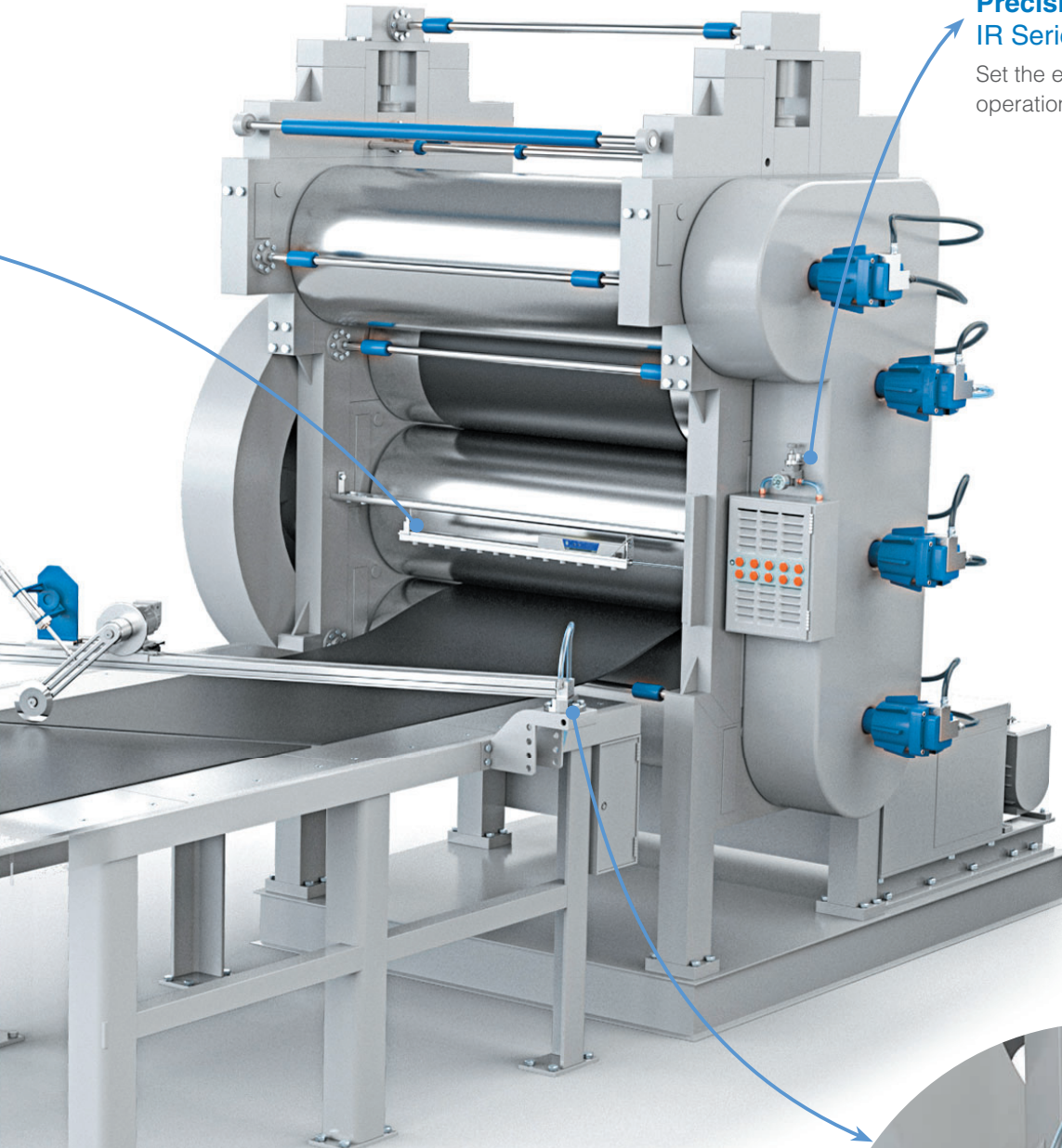

**Quick exhaust valve
ASV Series**

Ensure high-speed operation of the cutting blades with the ASV exhaust valve.



Bead building

From the wire preparation to the final assembly of the bead, each phase needs a precise control of the process conditions. Control the tension of the wire, ensure a correct winding and handle the finished parts easily with our products for each purpose.



Silencer
AN00 Series

Reduce noise at your plant without sacrificing low back pressure, thanks to the compact and easy mounting AN00 Series.



Round actuator
C85/CM2 Series

Guide the coiling process reliably with our stainless steel, long life round cylinder.



Electro-pneumatic regulator
ITV Series  IO-Link

Keep correct, constant wire tension with the ITV regulator.



Electric actuator
LEY Series

Unload finished beads precisely and smoothly, along with excellent endurance against foreign matter.

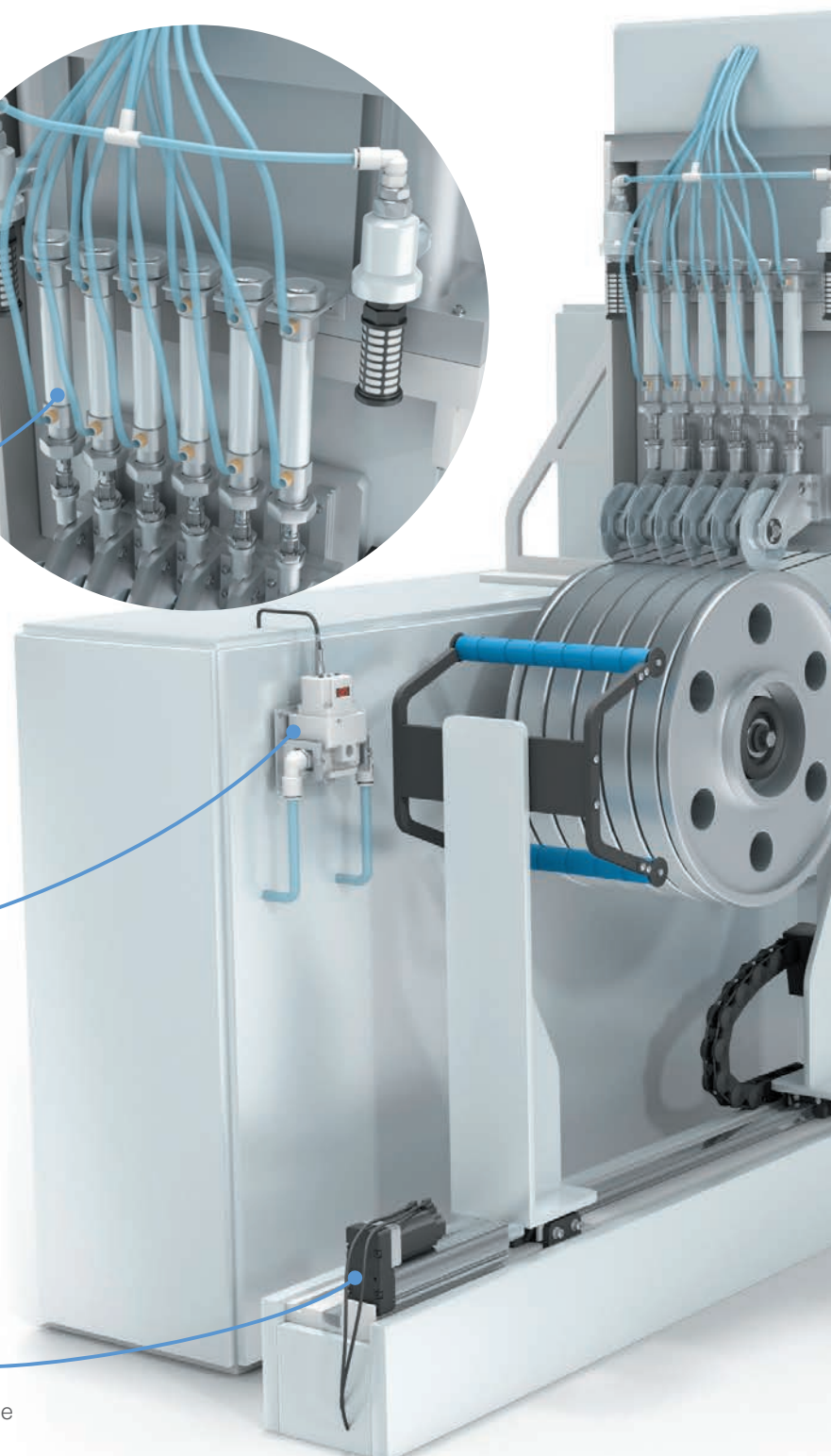
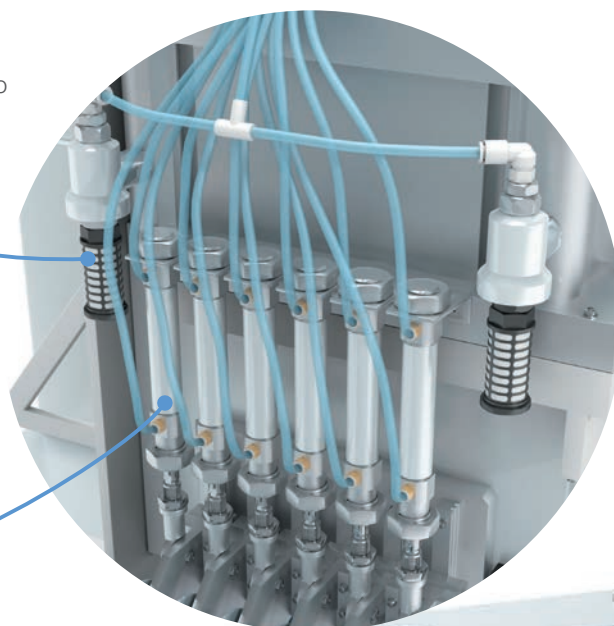

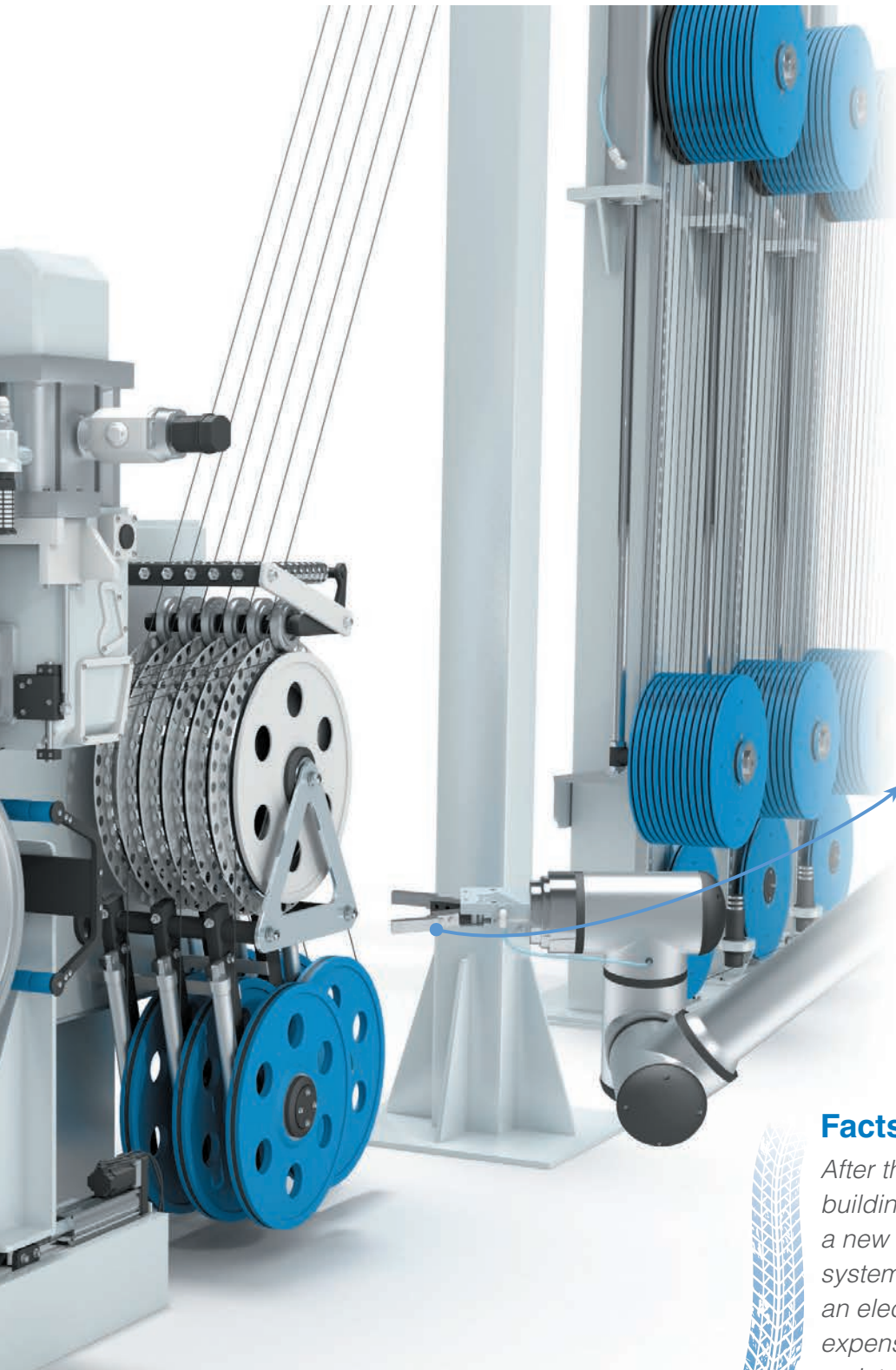

**Air gripper
MHC2 Series**

Grip and handle the beads with a compact, angular air gripper with reduced maintenance costs.

Facts over words

*After the need to improve the bead building stage, a customer requested a new solution to replace the gripping system that was carried out with an electromagnet. This system was expensive in terms of cost and maintenance, and spare parts were difficult to find. With SMC's proposal, this old system was replaced with **MHC2** pneumatic grippers, which proved to be an efficient solution that drastically reduced maintenance costs and labours.*

Tyre building



Large flow filter with differential pressure switch
AFF Series

Guarantee the process air quality to prevent operational failure, rust and contamination.



Compact guide cylinder with lock
MLGP-Z Series

Ensure a reliable operation of the transfer ring. Lock the clamps in the desired position.



Zoned manifold
SY Series

Centralise all the control valves in a compact manifold and reduce cables thanks to the IO link communication. Ensure safe and fast operation.

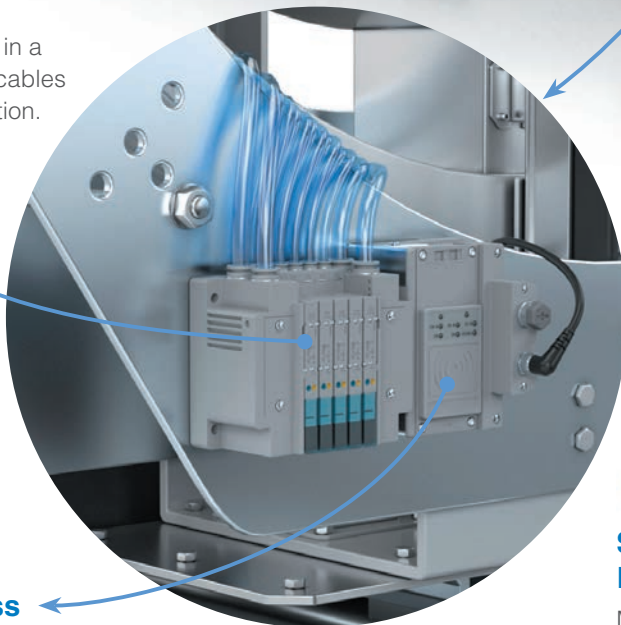

SI unit, wireless
EX600-W Series

Reduce installation and maintenance labours and avoid cables, connectors and breakage risks with the Wireless Fieldbus System.



Sine rodless cylinder
REA Series

Move the transfer ring fast and smoothly with our long stroke rodless cylinder.

This is by far, the most critical process in the tyre manufacturing process. For this stage, speed and reliability are the key to high productivity. With SMC, you can provide an innovative solution for your tyre building machine and help the process achieve the shortest time by digitalising the operations.

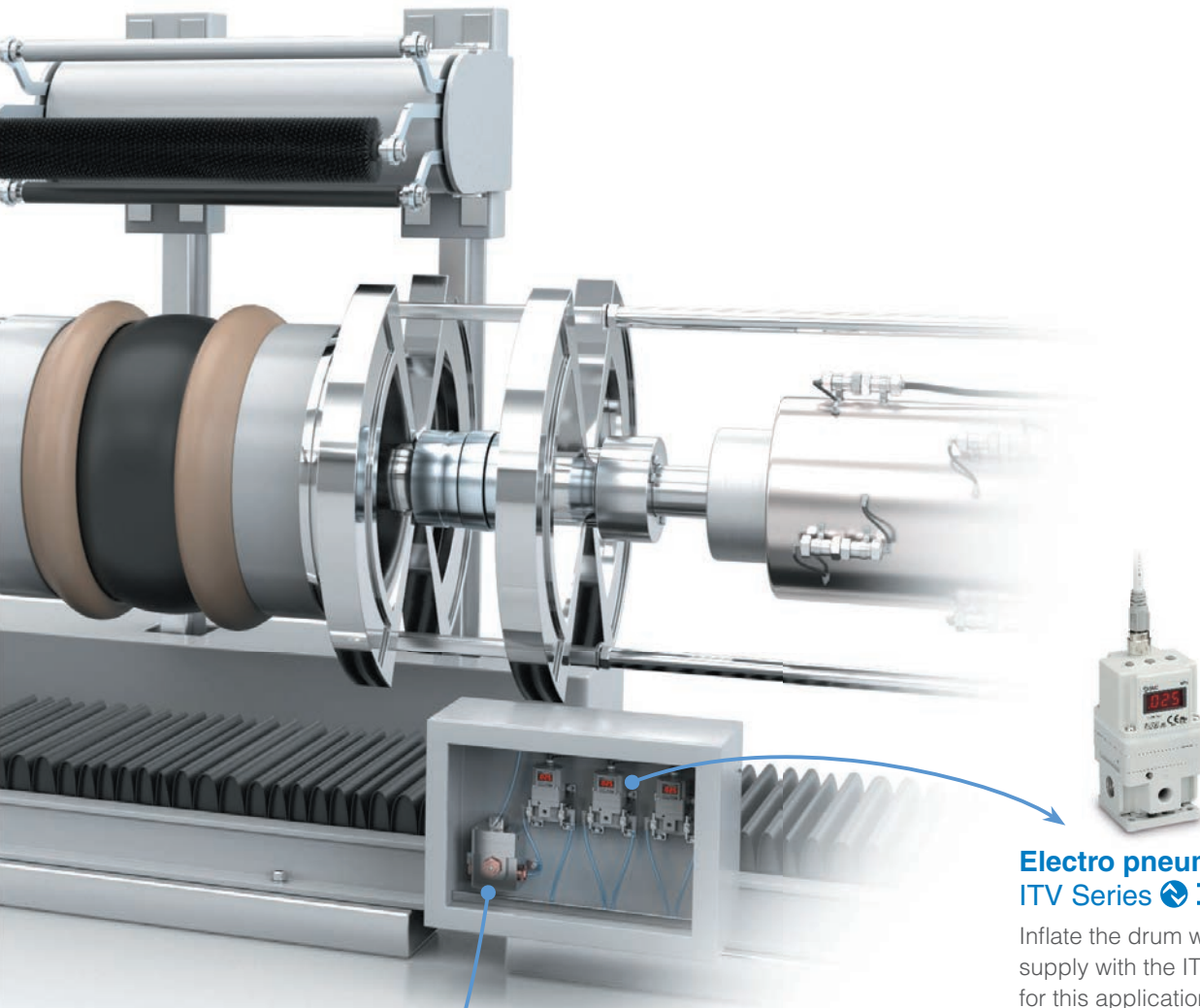

**Electro pneumatic regulator
ITV Series IO-Link**

Inflate the drum with a high-speed air supply with the ITV specially designed for this application.



**Power valve, precision
regulator
VEX1□0 Series**

Minimise pressure fluctuations with its large-volume supply/exhaust capability.

Facts over words

*Our customer had to ensure a precise pressure value for the inflating operation. Nevertheless, the product he was using only lasted two months before it started losing accuracy, making the process unstable. Thanks to SMC's precision regulator **VEX1□3□** Series, the customer experienced no problems for more than a year, thus having a more robust process and significantly reducing maintenance costs.*



Automatic leak detection system ALDS Series

Monitor and automatically detect machine leakages to reduce maintenance costs.



Actuator position sensor D-MP Series

Detect the cylinder position reliably and monitor every operation.

Facts over words

*A cylinder installed between the two moulds was used to unload the tyres after being cured. This cylinder was damaged quickly due to dirt and high temperatures, and it was difficult to carry out its maintenance because of difficult accessibility. SMC helped the customer to find a much more practical solution by installing our **C96-XC4** cylinder with heavy duty scraper outside the machine, immediately resolving accessibility and short life issues.*



Cylinder with heavy duty scraper C96/CA2 Series

Assure correct operation under the rough conditions of the process with our special heat resistant cylinder or with a heavy duty scraper.

During the curing process, high temperatures are generated, and it is important that the components behave correctly under these extreme conditions. We have a product for each of the operations taking part in this stage: spraying, loading and unloading, shaping, mould cooling and cleaning, and process valve automation.

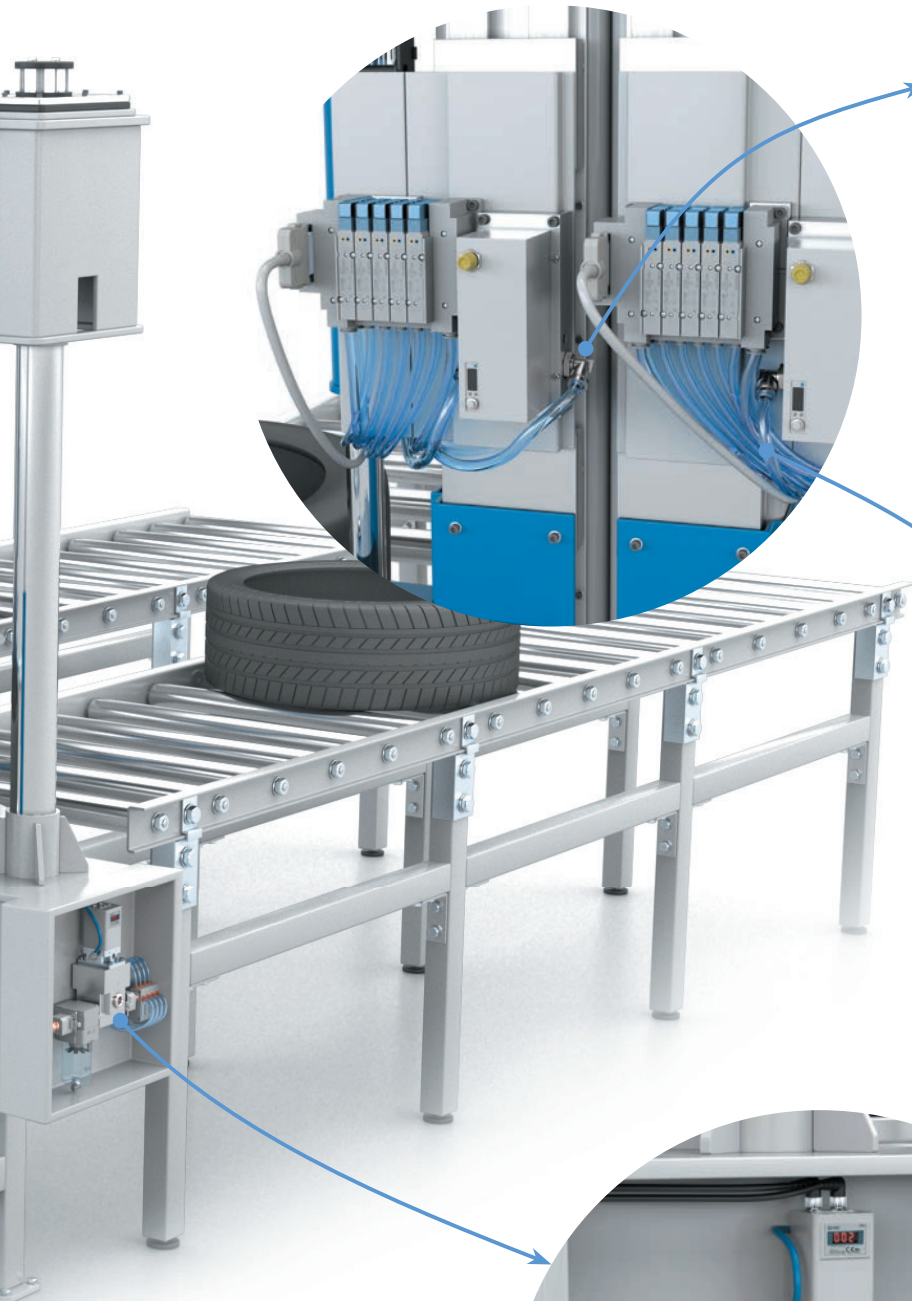

High environmental resistance fittings
KQG2 Series

Avoid corrosion and resist high temperatures derived from the vulcanizing operation.



High temperature tubing
TH Series

Guide the air safely despite the high temperatures generated during the curing process.



Stand-by valve
VEX-X115 Series

Reduce air consumption during short stops or shut it off during long ones.

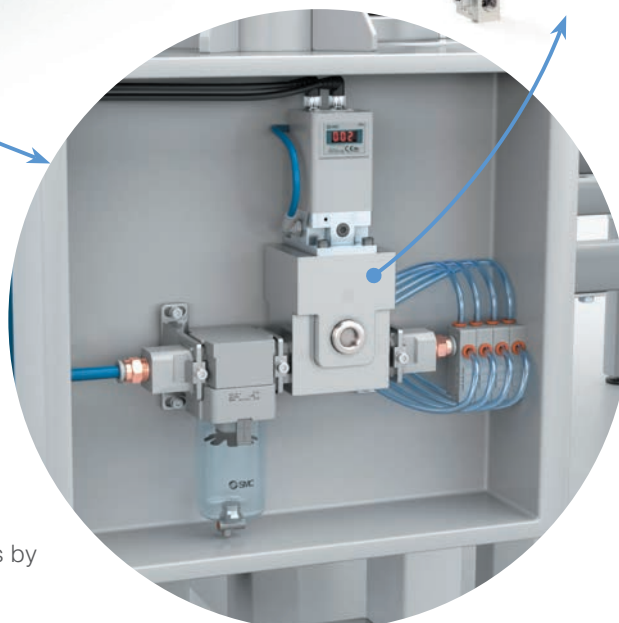

Air amplifier
ZH-X185 Series

Save energy while cooling the moulds by increasing the blowing airflow with ZH-X185 Series.

Inspection, handling and storage

It is crucial to verify that the tyres are sold without imperfections that could affect to their performance. Moreover, an efficient tyre handling, transportation and storage system can improve the overall plant productivity. SMC can help you to precisely control all the testing stages and get one step ahead in the digitalization of these processes, by integrating automated handling systems such as conveying lines and monitoring sensors.



Process pump PA3000 Series

Ensure a long life for the spraying systems used before the balancing test, thanks to the high abrasion resistance of the PA3000 Series.



Facts over words

*The compressed air of a balance testing operation was proven to contain water drops and oil mist, leading to inadequate air quality. By installing a combination of SMC's **water separator, filter and mist separator**, the air flow fulfilled the appropriate quality standards that the application required, leading to reliable operation.*



High capacity chiller HRS090 Series

Precisely control the temperature of the laser beam during the X-Ray inspection process with our large-capacity Thermo-chiller.



**Compact cylinder with solenoid valve
CVQ Series**

Save labour, energy and space with the integrated and compact solution CVQ Series.

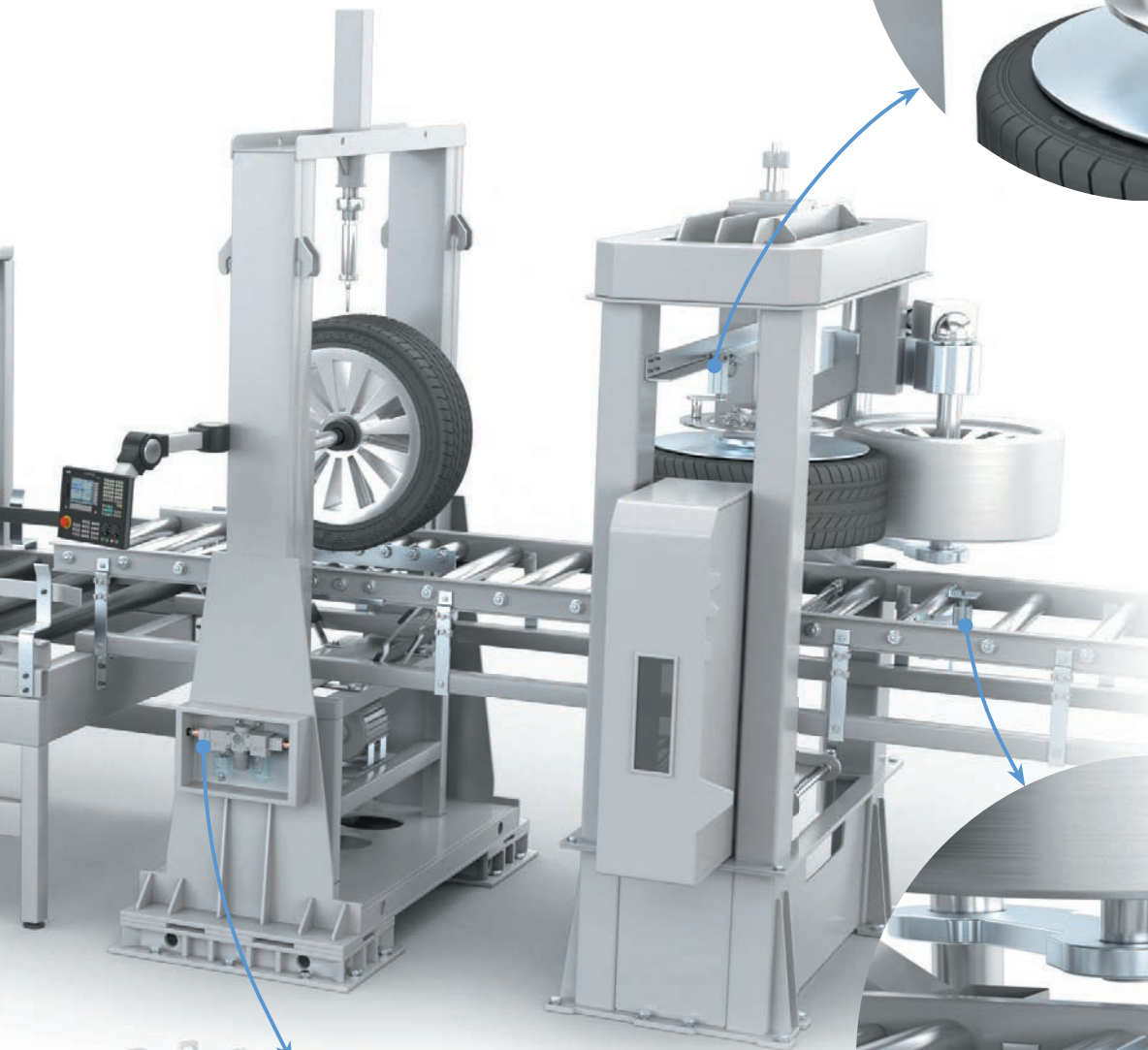
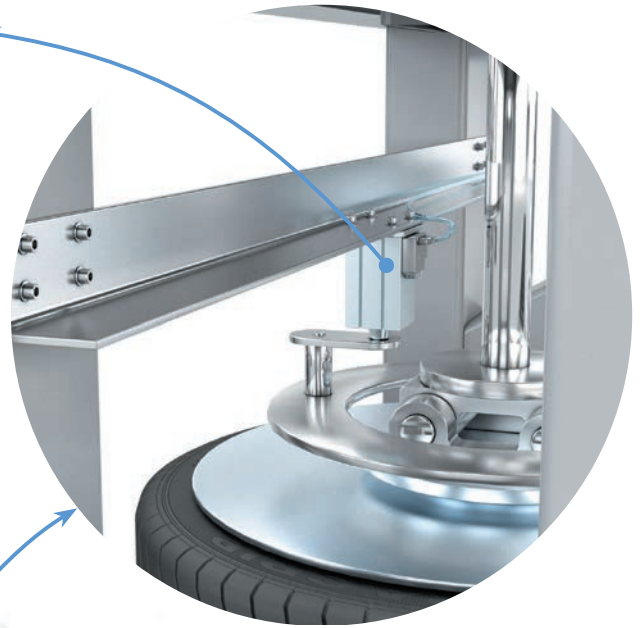

**FRL combination unit
AC-D Series**

Choose the combination unit that best adapts to your air quality requirements.

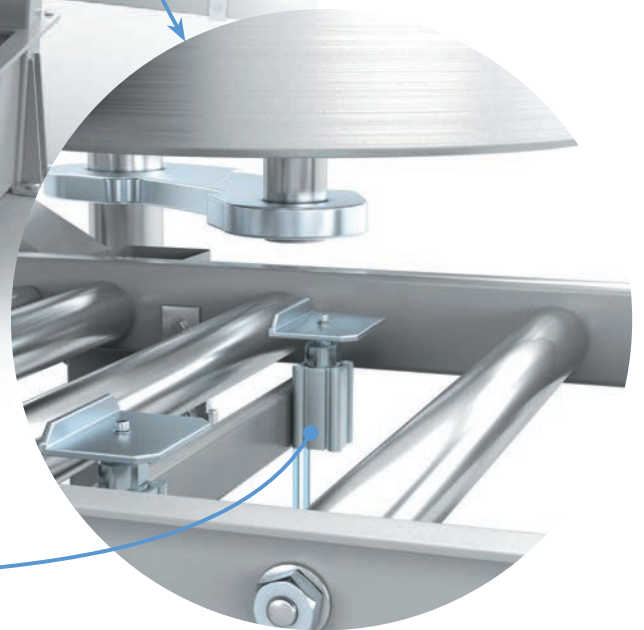

**Stopper cylinder
RSQ-Z Series**

Decelerate and stop the tyres smoothly while transporting them through different testing operations.

SMC strategic partnership program

Our 12 commitments to you

One of the things we do best at SMC is being close to our customers.

The tyre industry has always given top priority to innovation, competitiveness and sustainability, and with SMC and our 12 commitments, you'll find the partner you need to excel in taking on these challenges.



1 Dedicated corporate account manager

An SMC Corporate Account Manager is assigned as your one-point person of contact. They work closely with your Corporate HQ Sponsors, Engineers and all production facilities - to deliver, create, manage and execute all collaborative program objectives.



2 Local factory support

SMC has over 6,000 local sales engineers in 82 countries to support all of your local production facilities.



3 Design engineering support

To fully support your Engineers - SMC has 1600 dedicated R&D Engineers that can develop new products or solutions. SMC can quickly customize or modify existing components to meet design standards or unique applications.



7 Compressed air energy savings assessments

SMC has developed a Streamlined Energy Savings Assessment program for our Corporate Accounts. Our goal is to find innovative solutions to reduce waste of compressed air in the factory environment.



8 Machine analysis assessments

SMC will perform plant level machine analysis to improve machine performance, identify waste, reduce scrap rate and improve line efficiency.



9 Storeroom assessments

SMC will perform plant level storeroom assessments to reduce vendor base, eliminate duplication, standardize components, identify critical spares and offer cost savings solutions.



4 Machine safety support

SMC will work with your Engineering and local facilities for design assistance related to plant safety upgrades to meet ISO 13849-1 or other Machine Directives.



5 OEM machine supplier support

SMC will support your OEM Machine suppliers with the integration of SMC specified components. SMC will provide pricing support, innovative design assistance and SMC project management to ensure on-time delivery and commissioning of new machines or lines.



6 Critical spare parts for new OEM machines

SMC will work with local factories receiving new OEM machines - to ensure all critical spare parts are available and onsite prior to production.



10 High usage spare parts analysis

SMC will work with all local plants to identify high usage pneumatic components. SMC will conduct failure mode analysis and offer robust alternatives to ensure better performance and uptime on machines where components are used.



11 Improvement activity reports

SMC will document all Corporate Account application successes with Improvement Activity Reports (IAR's). These IAR's are a one-page overview of the application - highlighting operational improvements, energy savings, cost savings details or plant process improvements. These IAR's are designed to be shared with other facilities to duplicate activity.



12 Onsite & online training classes

SMC offers customized onsite and online training classes - on a variety of subjects related to pneumatic components, electric actuators, energy savings, optimal machine design and TPM methodologies.

SMC's global engineering network

- ▶ **JTC** (Japan Technical Center) Japan
- ▶ **CTC** (China Technical Center) China
- ▶ **UTC** (U.S. Technical Center) United States of America
- ▶ **ETC** (European Technical Centre) United Kingdom
- ▶ **GTC** (German Technical Centre) Germany

With 532 sales offices in 82 countries worldwide, our sales force of over 8,700 experts maintains close communication with customers.

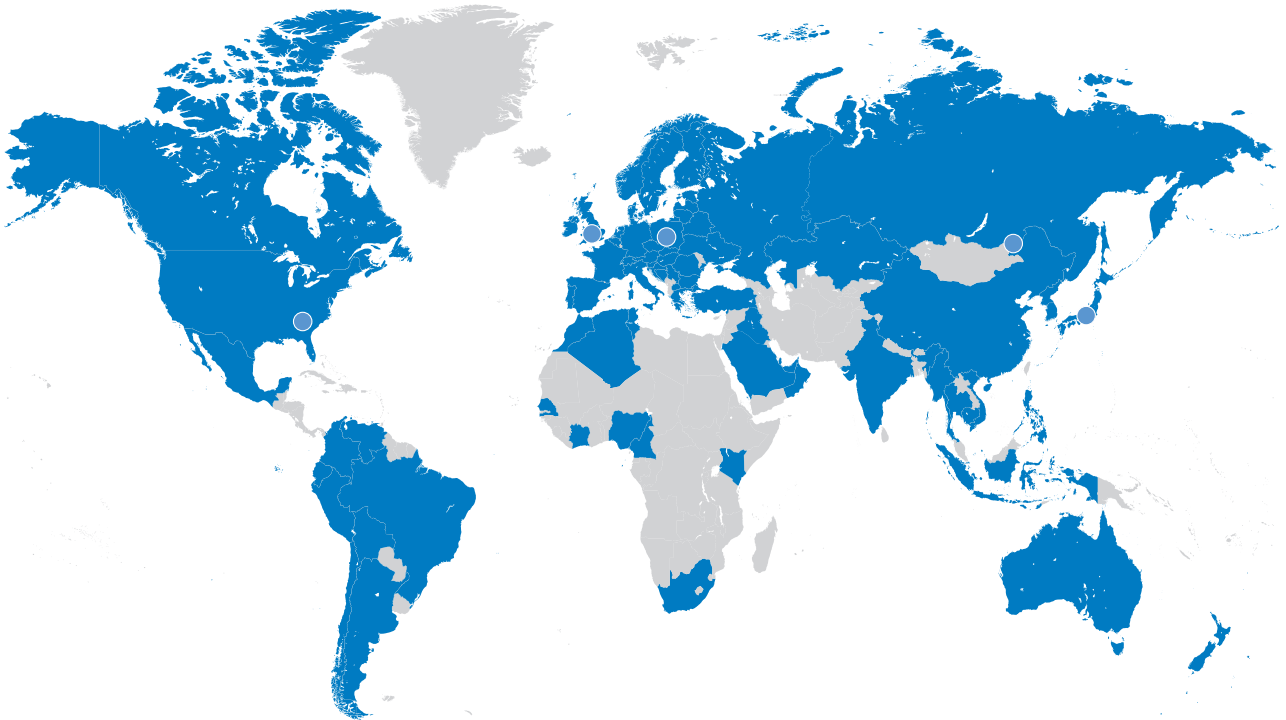

SMC's production and supply network

▶ Domestic production facilities (Japan)

- Soka Factory (Saitama Pref.)
- Kamaishi Factory (Iwate Pref.)
- Tsukuba Factory (Ibaraki Pref.)
- Tono Factory (Iwate Pref.)
- Shimotsuma Factory (Ibaraki Pref.)
- Yamatsuri Factory (Fukushima Pref.)
- Distribution Center (Ibaraki Pref.)

▶ Key overseas production facilities

- China Factory
- Singapore Factory
- India Factory

▶ Overseas local production facilities

- United States of America
- Brazil
- Mexico
- Germany
- United Kingdom
- Italy
- Austria
- Finland
- France
- South Africa
- Spain
- Sweden
- Switzerland
- Turkey
- Russia
- Czech Republic
- Australia
- Korea
- China (Guangzhou)
- Hong Kong
- Malaysia
- New Zealand
- Philippines
- Singapore
- Taiwan
- Thailand
- Vietnam



Expertise – Passion – Automation

SMC Corporation

Akihabara UDX 15F, 4-14-1
Sotokanda, Chiyoda-ku, Tokyo 101-0021, JAPAN
Phone: 03-5207-8249
Fax: 03-5298-5362

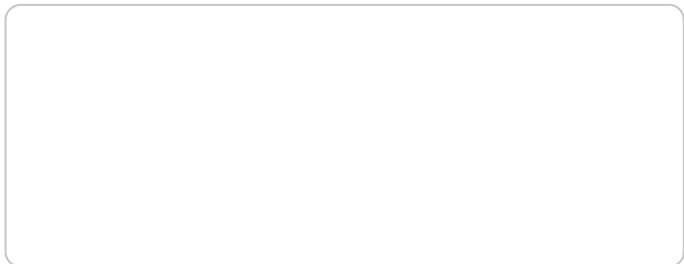

Austria	+43 (0)2262622800	www.smc.at	office@smc.at
Belgium	+32 (0)33551464	www.smc.be	info@smc.be
Bulgaria	+359 (0)2807670	www.smc.bg	office@smc.bg
Croatia	+385 (0)13707288	www.smc.hr	office@smc.hr
Czech Republic	+420 541424611	www.smc.cz	office@smc.cz
Denmark	+45 70252900	www.smc.dk.com	smc@smcdk.com
Estonia	+372 6510370	www.smc.ee	smc@smcpneumatics.ee
Finland	+358 207513513	www.smc.fi	smc@smc.fi
France	+33 (0)164761000	www.smc-france.fr	info@smc-france.fr
Germany	+49 (0)61034020	www.smc.de	info@smc.de
Greece	+30 210 2717265	www.smchellas.gr	sales@smchellas.gr
Hungary	+36 23513000	www.smc.hu	office@smc.hu
Ireland	+353 (0)14039000	www.smcautomation.ie	sales@smcautomation.ie
Italy	+39 03990691	www.smcitalia.it	mailbox@smcitalia.it
Latvia	+371 67817700	www.smc.lv	info@smc.lv

Lithuania	+370 5 2308118	www.smclt.lt	info@smclt.lt
Netherlands	+31 (0)205318888	www.smc.nl	info@smc.nl
Norway	+47 67129020	www.smc-norge.no	post@smc-norge.no
Poland	+48 222119600	www.smc.pl	office@smc.pl
Portugal	+351 214724500	www.smc.eu	apoioclientept@smc.smces.es
Romania	+40 213205111	www.smcromania.ro	smcromania@smcromania.ro
Russia	+7 8127185445	www.smc-pneumatik.ru	info@smc-pneumatik.ru
Slovakia	+421 (0)413213212	www.smc.sk	office@smc.sk
Slovenia	+386 (0)73885412	www.smc.si	office@smc.si
Spain	+34 945184100	www.smc.eu	post@smc.smces.es
Sweden	+46 (0)86031240	www.smc.nu	smc@smc.nu
Switzerland	+41 (0)523963131	www.smc.ch	info@smc.ch
Turkey	+90 212 489 0 440	www.smc-pnomatik.com.tr	info@smcpnomatik.com.tr
UK	+44 (0)845 121 5122	www.smc.uk	sales@smc.uk